



University of Dammam  
College of Computer Science & Information  
Technology - Computer Science Department  
Dammam, Saudi Arabia

# iTrack

## Wireless Energy Consumption Monitoring System

### Team Members:

Fatimah Al Shaer

Khadijah Al Safwan

Khawla Aseeri

Lolah Hakami

Masoumah Al Jishi

### Supervisor:

Dr. Dilek Düştegör



# Outline

- Introduction
- Project Development Life-Cycle
- Project Implementation
- Project Testing
- Project Deployment
- Project Challenges and Difficulties
- Conclusion
- Demo (outline)
- Recommendations

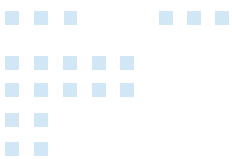

“I can't decide which is worse, no electricity or unreliable electricity. I wonder if I'll ever have to decide which is worse, life as we're living or no life at all”.

*Susan Beth Pfeffer*

Khadijah Al Safwan



# Introduction

## (Motivation)



# Introduction

## (Motivation)



Khadijah Al Safwan



# Introduction

## (Objectives)

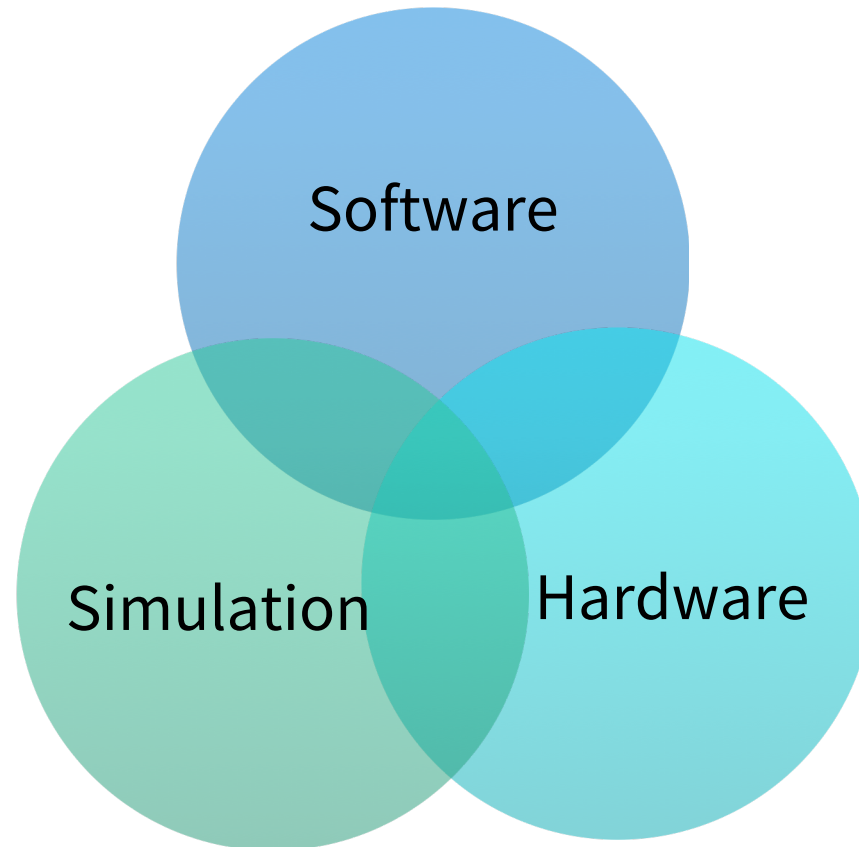

Khadijah Al Safwan





# Project Development Life-Cycle

Khadijah Al Safwan

# Project Development Life-Cycle

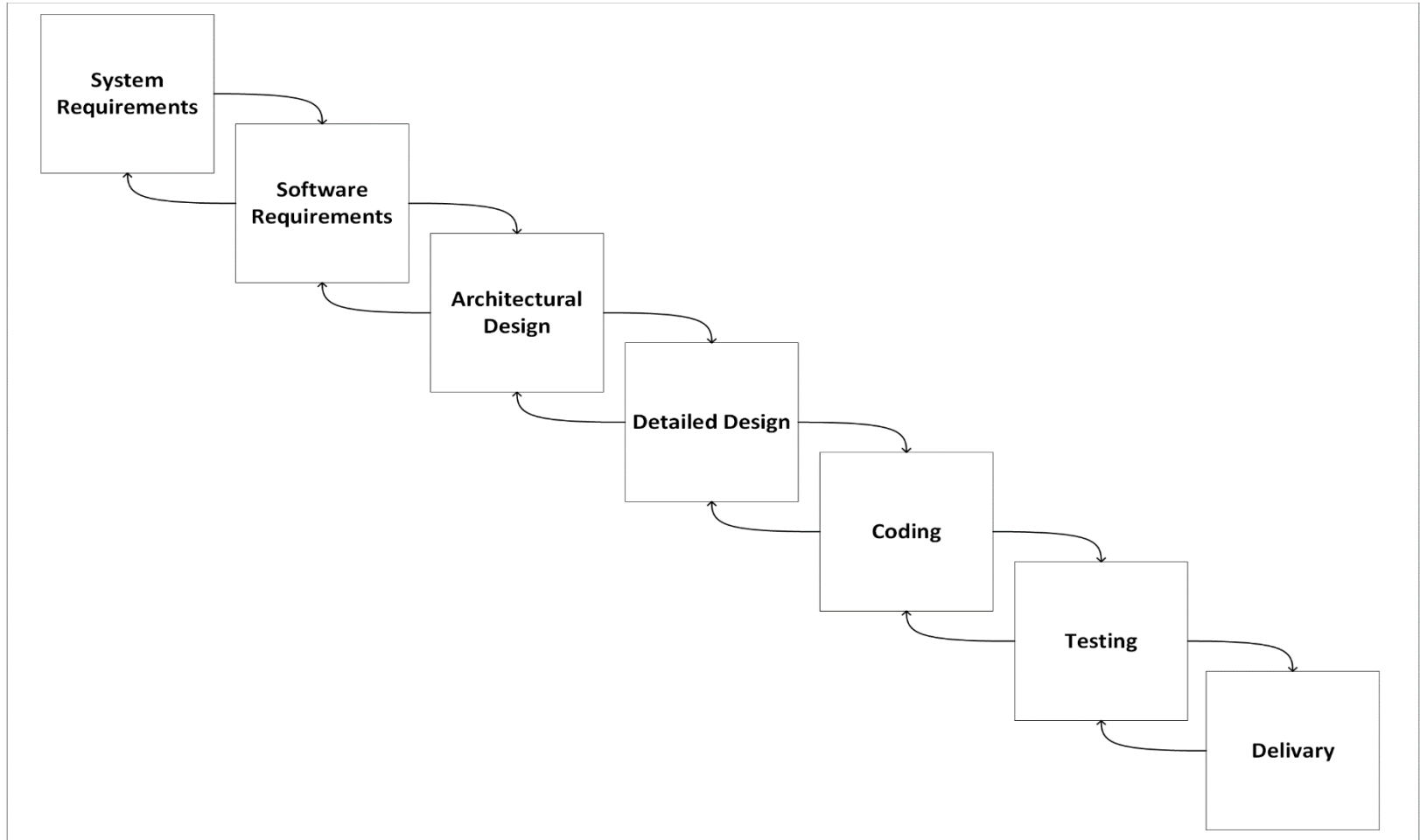





# **Project Implementation**

**Practices and Result**

Lolah Hakami

# Project Implementation (Practices)

System software development

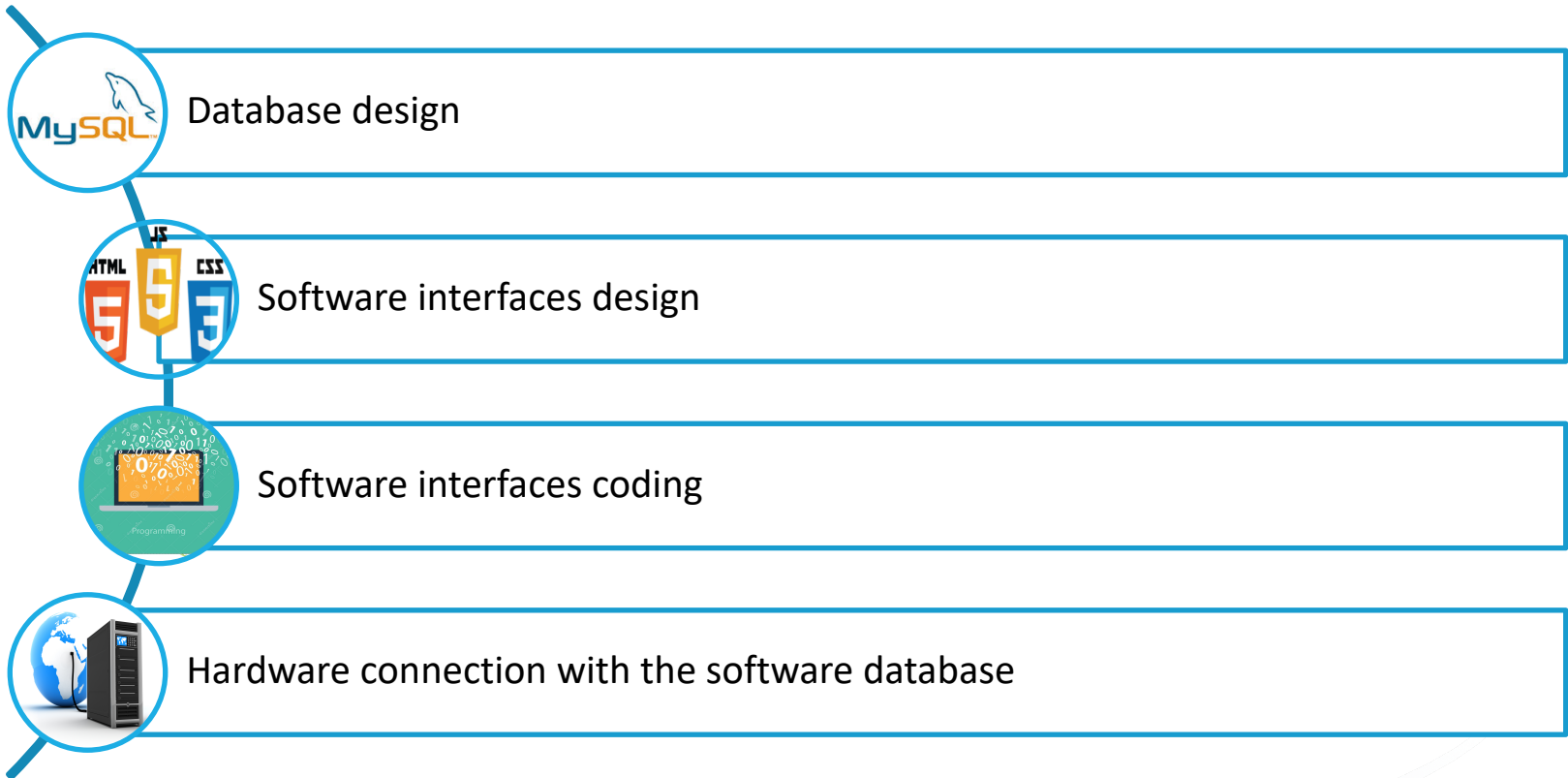

Lolah Hakami

# Project Implementation (Practices)

System hardware prototype development



# Project Implementation

## (Result)

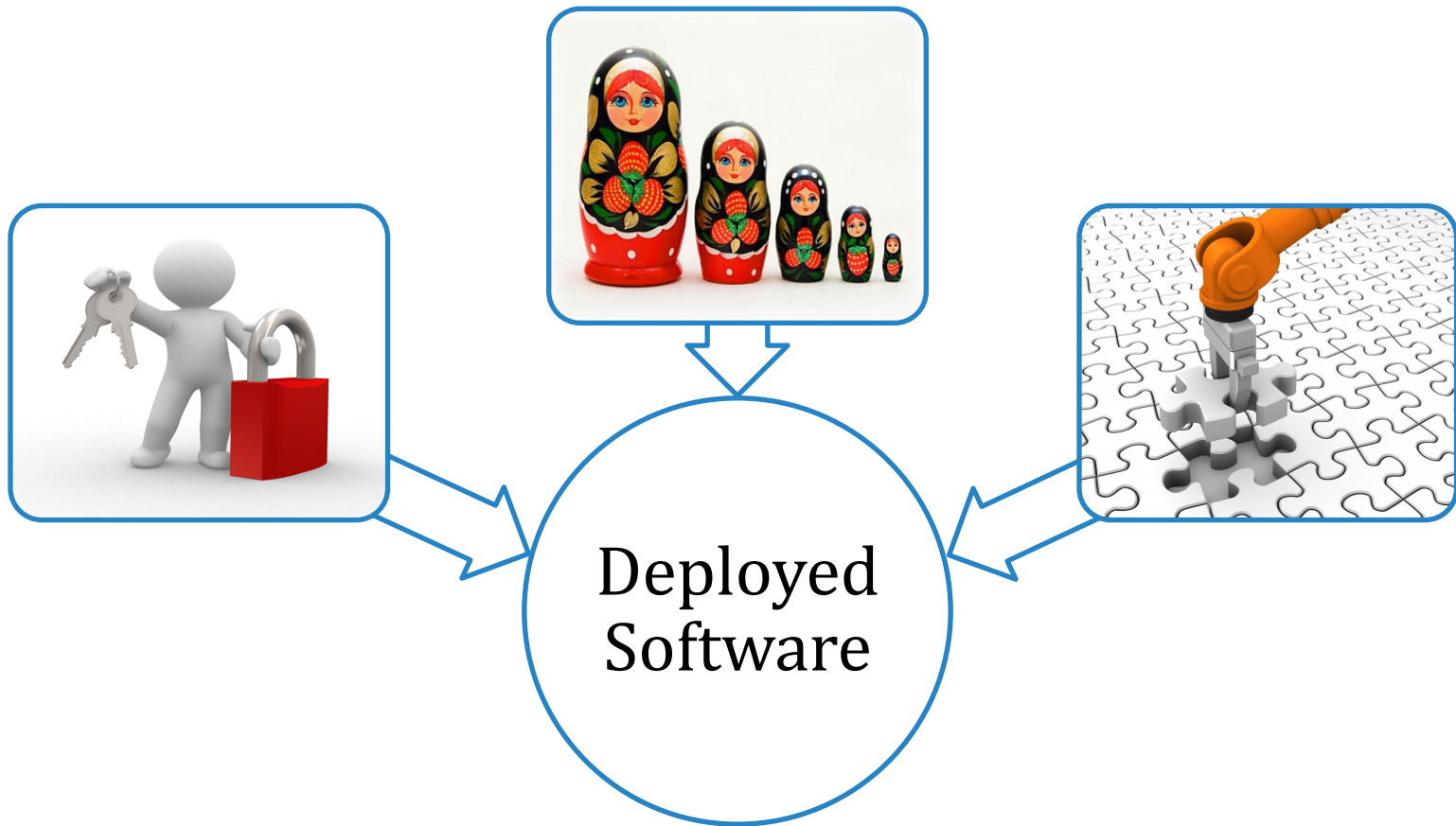

# Project Implementation

## (Result)



Fatimah Alshaer



# Project Testing

## Practices and Result

Khawlah Aseeri

# Project Testing (Practices)

Functional requirement testing



# Project Testing (Practices)

Non-functional requirement testing



Khawlah Aseeri



# Project Testing (Practices)

## Simulation

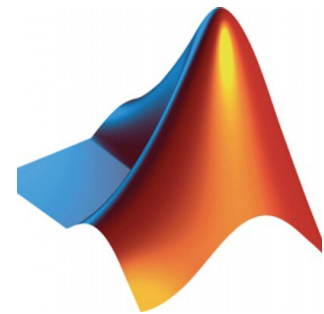
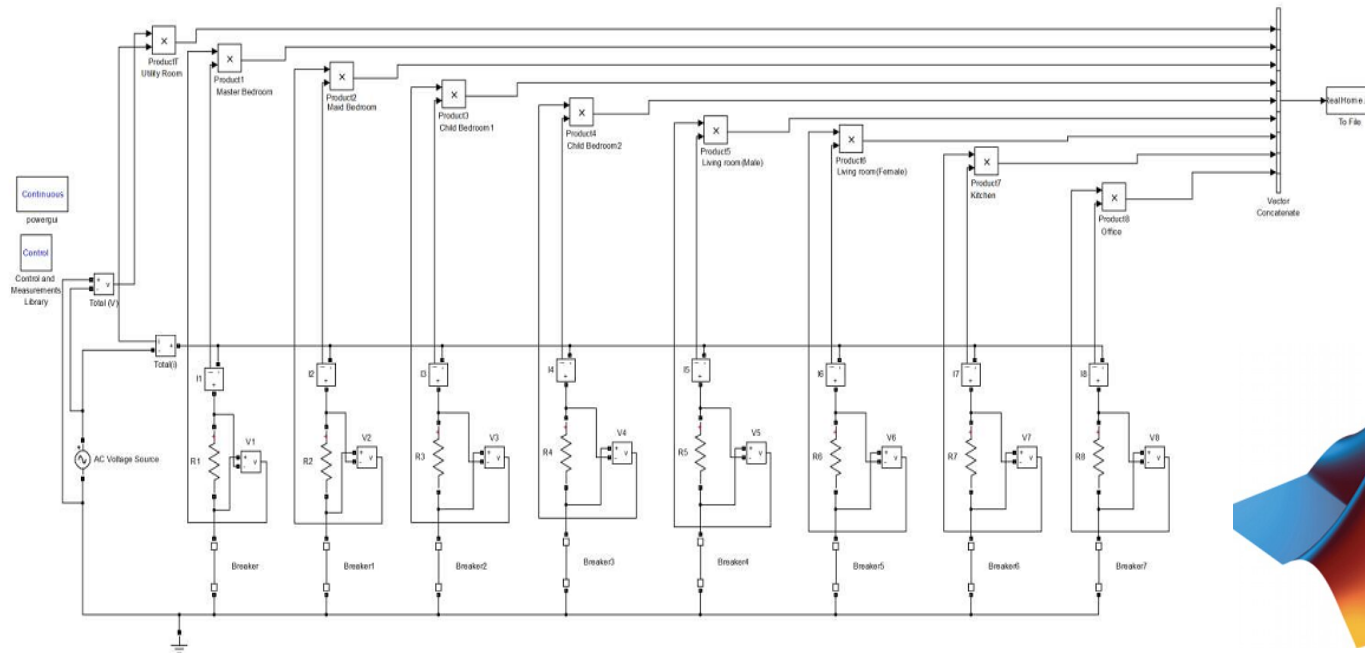

# Project Testing (Practices)

## Simulation

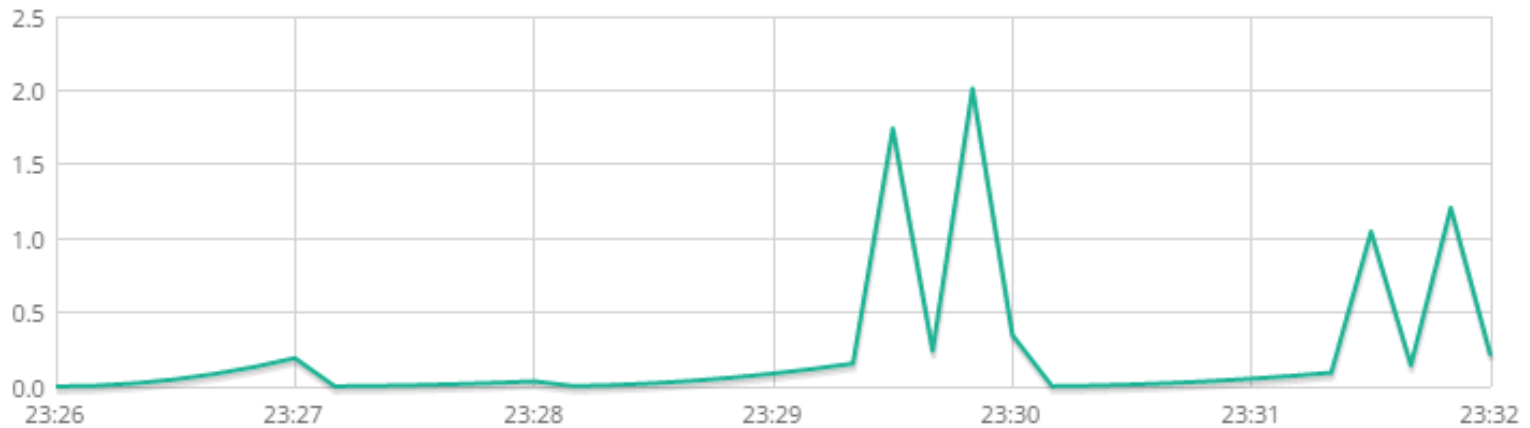

Khawlah Aseeri

# Project Testing (Result)



Khawlah Aseeri



# Project Deployment

Practices and Result

Khadijah Al Safwan

# Deployment Phase

## (Practices)

cPanel®



**HOSTING**24  
FIRST CLASS WEB HOSTING



Khadijah Al Safwan

# Deployment Phase (Result)

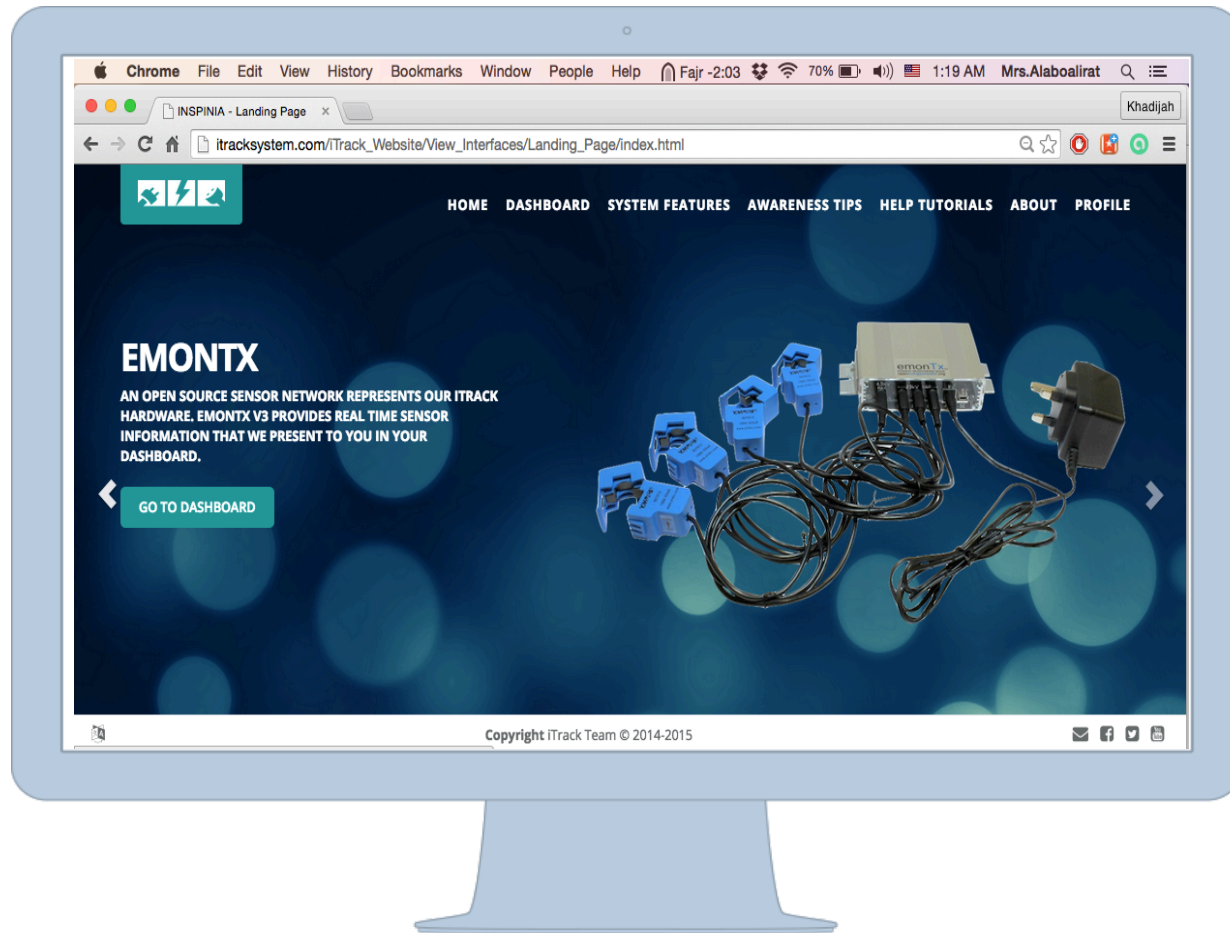

Khadijah Al Safwan



# **Project Challenges and Difficulties**

Masoumah Al Jishi

# Project Challenges and Difficulties

Software development phase

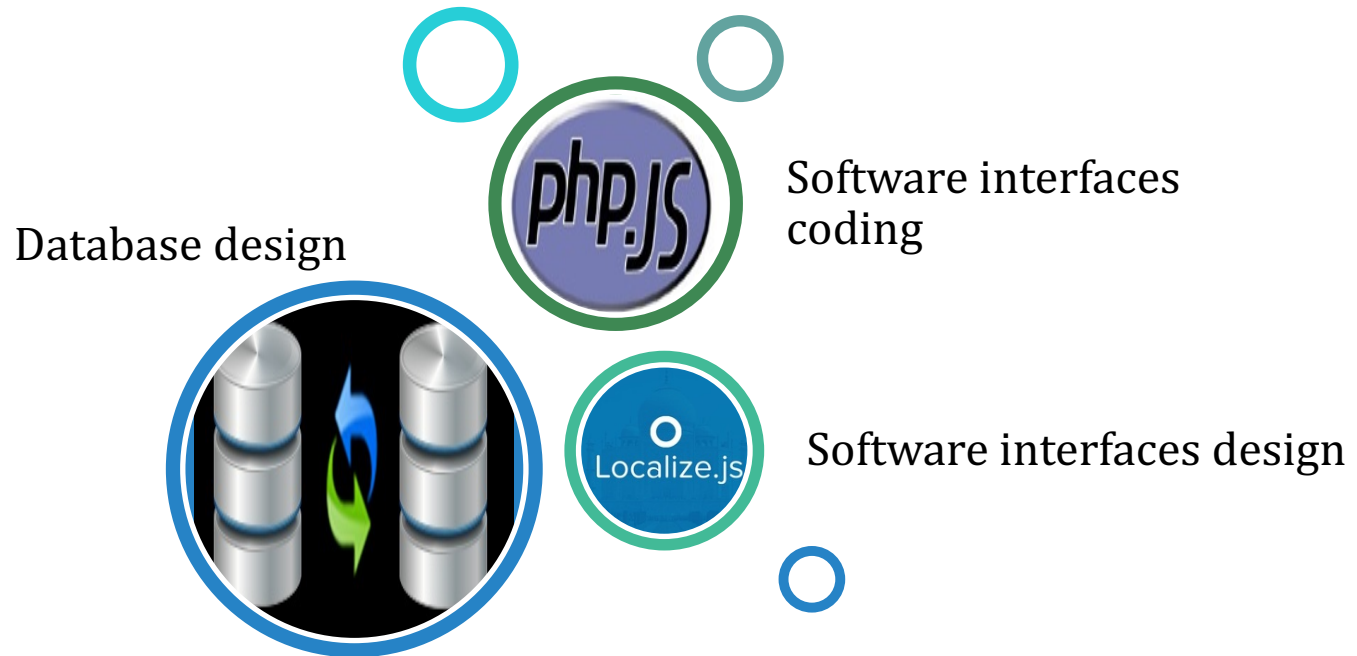



# Project Challenges and Difficulties

## Hardware configuration

Hardware connection with the  
software database

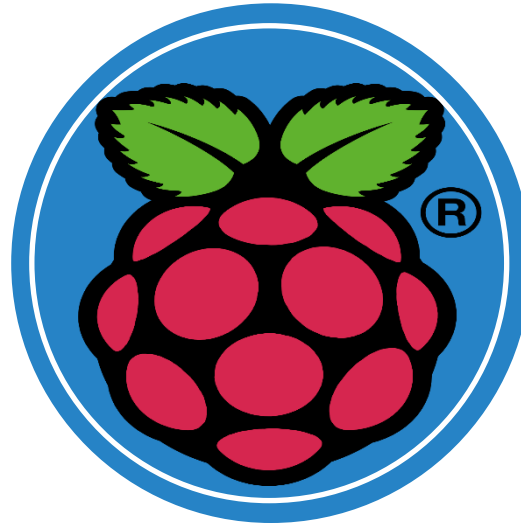

Masoumah Al Jishi

# Project Challenges and Difficulties

Deployment phase

Hosting



Masoumah Al Jishi

# Project Challenges and Difficulties

Testing phase

Simulation

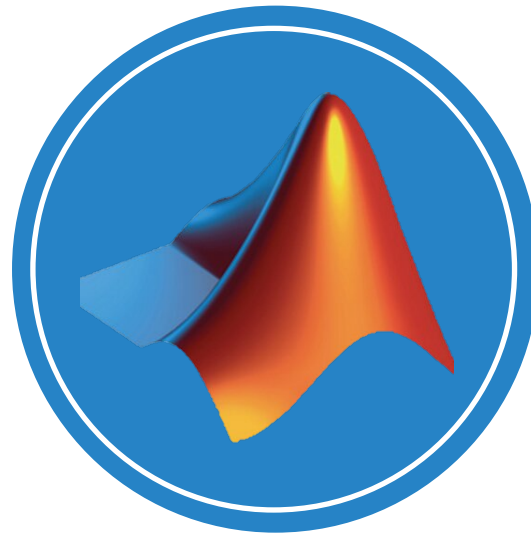

Masoumah Al Jishi



# Conclusion

Khadijah Al Safwan

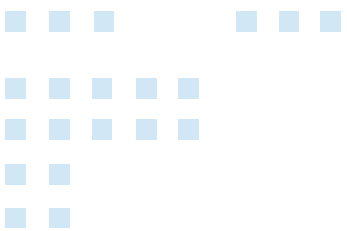

# Demonstration

## Overview

Fatimah Al Shaer

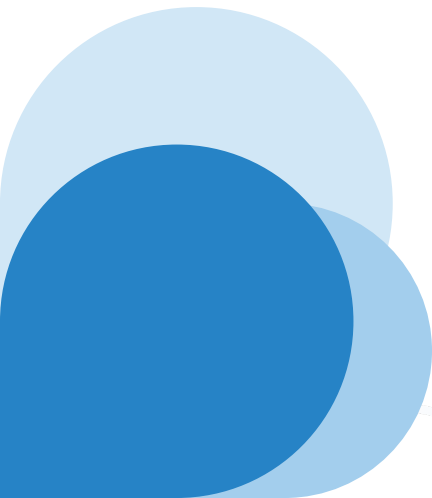



# Demonstration

## (Overview)

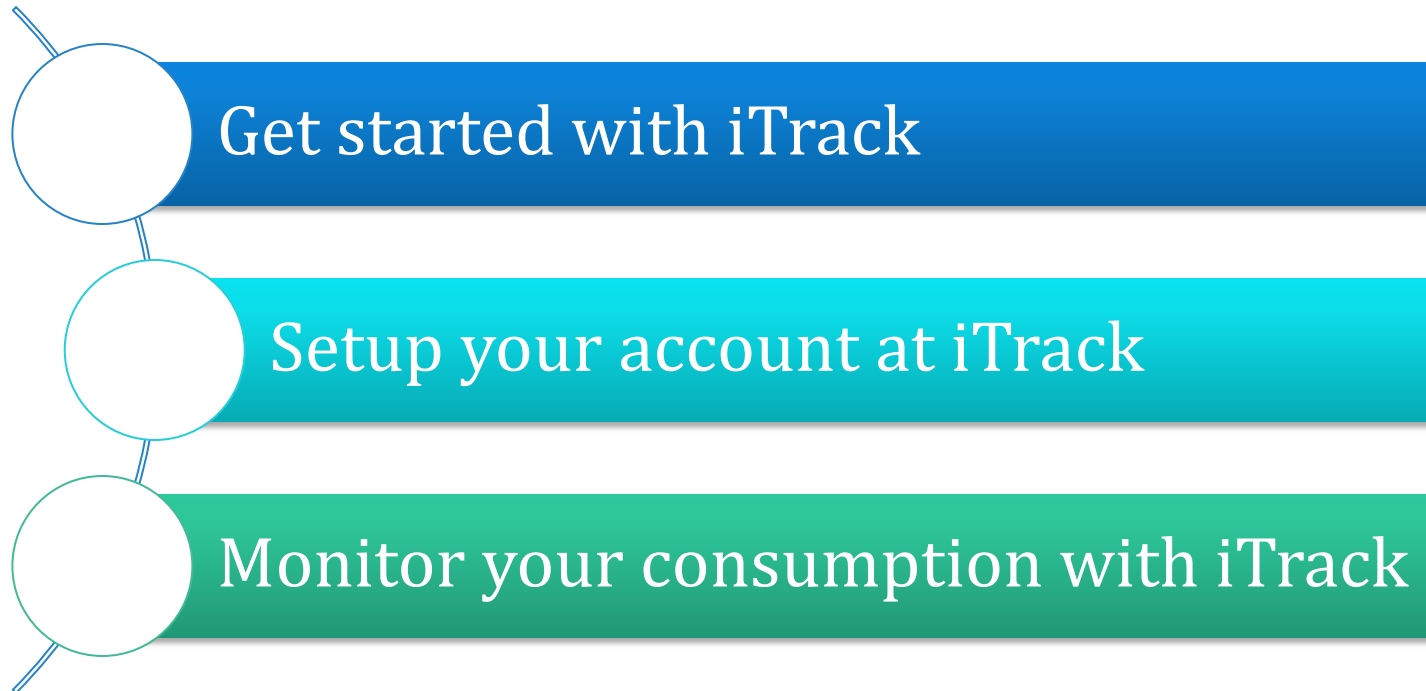



# Recommendations



# Recommendations

## Software



- Integration with Saudi electrical company
- Enhancement of iTrack features
- Error detection techniques
- Learning techniques

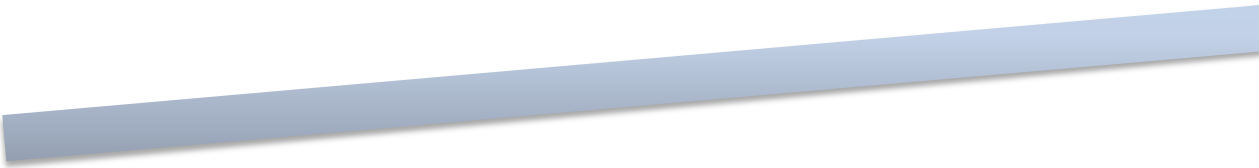

## Hardware

- Development hardware device
- Investigation of the hardware network

